

Catalogue Cable Trunkings

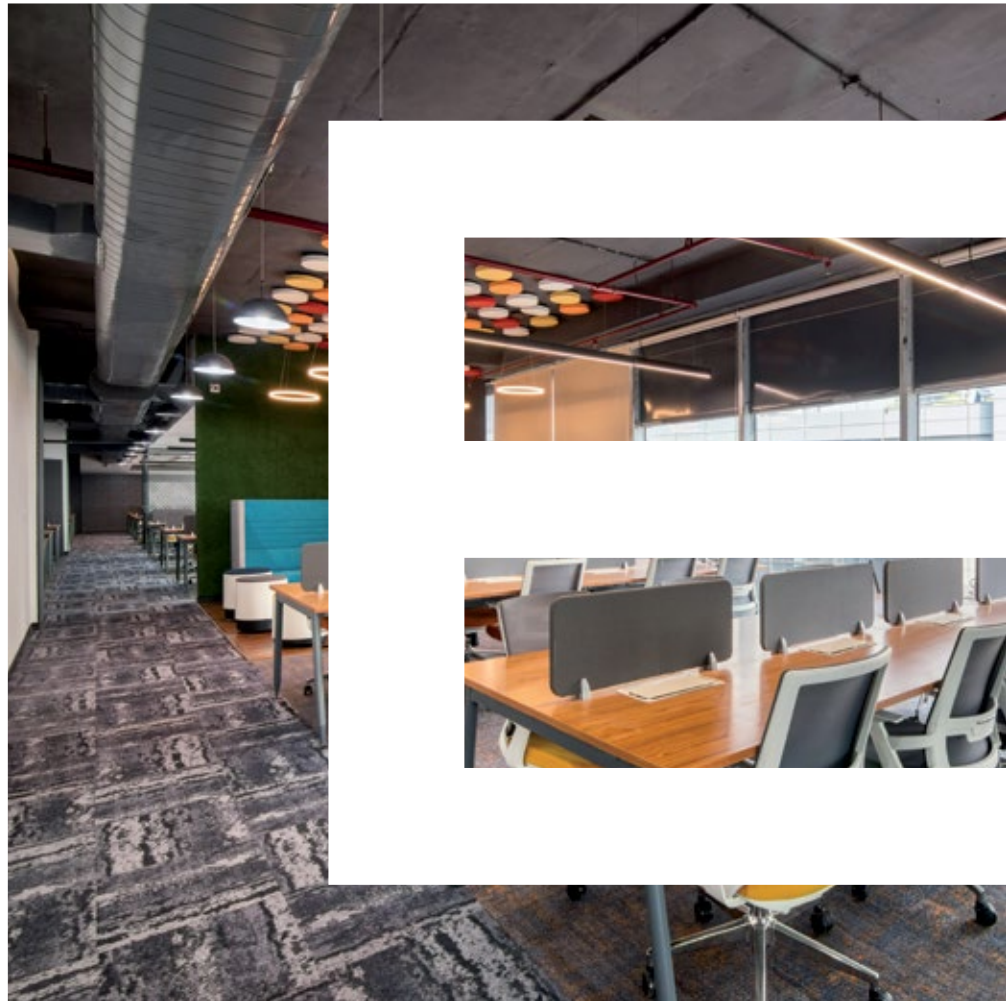

New Trunking for Distribution L45 Cover - Snap-ON

NEW

Snap-On for simple installation!

The new **L45 Cover - Snap-ON**, trunking system, allows, with just one click, to install the **MEC Q45** mechanisms in a simple and easy way.



Contents

Cable Trunkings in PVC

ETS 10 - Cable Trunkings for Electrical and Telecommunication Installations	2
Mini Cable	4
Distribution	6
- L45 Cover - Snap-ON 	6
- L75 Cover - Universal	6
Skirt and Floor	8
- Accessories for mounting devices	10
ETS 13 - Cable Trunkings for Protection of Cables and Pipes	12
ETS 14 - Cable Trunkings for Panelboards	14

Halogen Free Cable Trunkings in PC/ABS

ETS 10 - Cable Trunkings for Electrical and Telecommunication Installations	17
Mini Cable	18
- Accessories for mounting devices	18
Distribution	20
- L75 Cover - Universal	20
- Accessories for mounting devices	20
ETS 14 - Cable Trunkings for Panelboards	22

Technical Information	25
------------------------------	----

ETS 10

for electrical and telecommunication installations

Cable Trunkings for Electrical and Telecommunication Installations (PVC)

Flexible and suitable for different mounting conditions. They allow the application of the different series of EFAPEL flush mounting mechanisms.

- Available in halogen free version
- With and without adhesive
- Variables angles
- IP44 Protection Degree
- Trunking supplied with protective film.
- High impact resistance

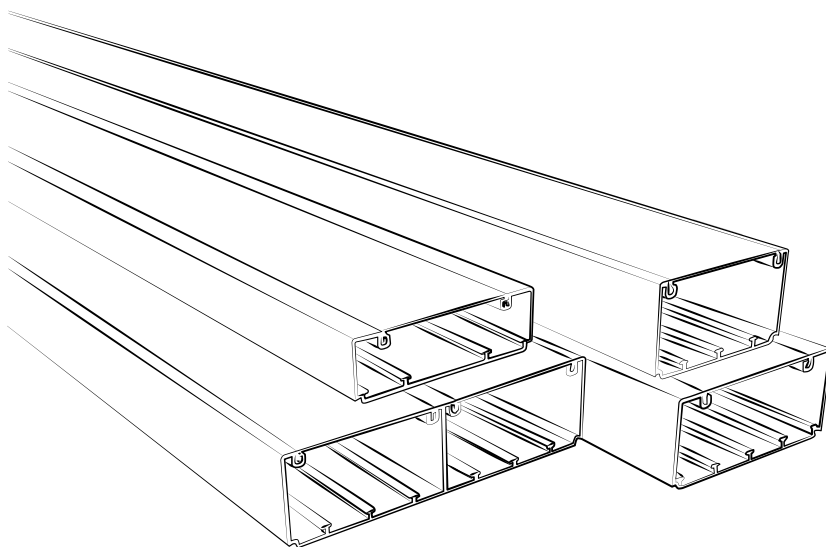

mini cable

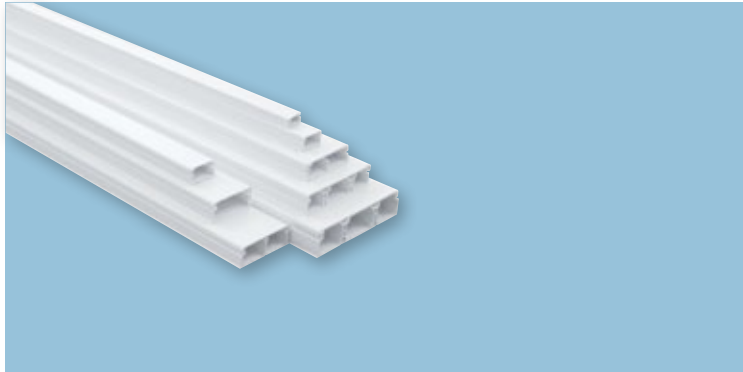

distribution

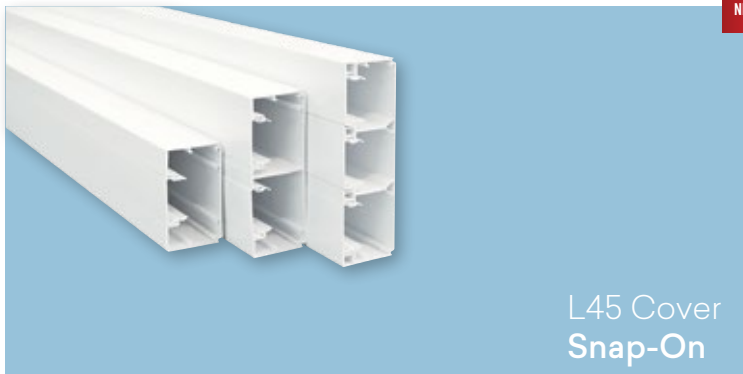

L45 Cover
Snap-On

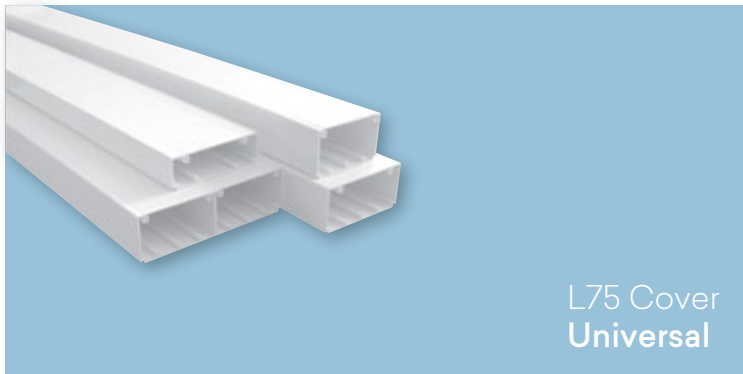





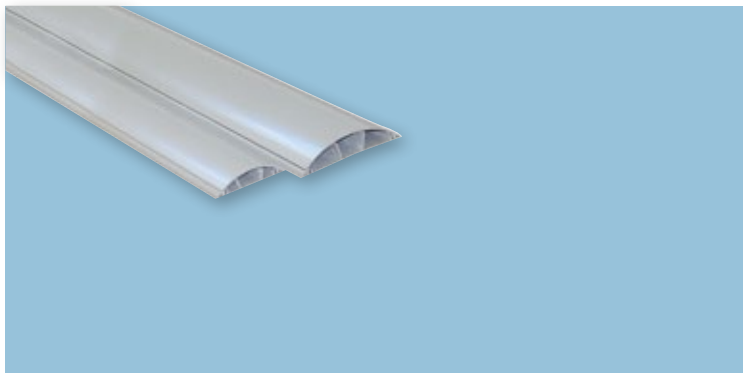















L75 Cover
Universal

skirt
and floor

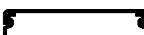

Accessories for mounting cable trunkings

Mini Cable					
W x H (mm)	Profile	Ref.	Top	Joint	Derivation
12 x 7		10010 CBR 10010 FBR	10015 ABR	10014 ABR	10011 ABR
16 x 10		10020 CBR 10020 FBR	10025 ABR	10024 ABR	10021 ABR
20 x 12,5		10030 CBR 10030 FBR	10035 ABR	10034 ABR	10031 ABR
25 x 16 NEW		10450 CBR 10450 FBR	10455 ABR	10454 ABR	10451 ABR
32 x 12,5		10410 CBR 10410 FBR	10405 ABR	10404 ABR	10401 ABR
		10400 CBR 10400 FBR			
32 x 16		10040 CBR 10040 FBR	10045 ABR	10044 ABR	10041 ABR
40 x 12,5		10050 CBR 10050 FBR	10055 ABR	10054 ABR	10051 ABR
		10150 CBR 10150 FBR			
40 x 16		10060 CBR 10060 FBR	10065 ABR	10064 ABR	10061 ABR
		10160 CBR 10160 FBR			
40 x 25 NEW		10480 CBR	10485 ABR	10484 ABR	10481 ABR
50 x 20		10500 CBR	10505 ABR	10504 ABR	10501 ABR
		10510 CBR			
		10520 CBR			
60 x 16		10070 CBR	10075 ABR	10074 ABR	10071 ABR
		10170 CBR			
75 x 20		10140 CBR	10145 ABR	10144 ABR	10141 ABR

CBR - White Complet; FBR - Adhesive White Complet; ABR - White Accessory.



Variable Outside Angle	Variable Inside Angle	Variable Plane Angle	Junction Box 80x80x20	Junction Box 80x80x30	Junction Box 110x110x50			
10016 ABR (Not Variable)	10012 ABR (Not Variable)	10013 ABR (Not Variable)						
10026 ABR (Not Variable)	10022 ABR (Not Variable)	10023 ABR (Not Variable)						
10036 ABR	10032 ABR	10033 ABR						
10456 ABR	10452 ABR	10453 ABR						
10406 ABR	10402 ABR	10403 ABR						
10046 ABR	10042 ABR	10043 ABR						
10056 ABR	10052 ABR	10053 ABR				10991 ABR	10998 ABR	10993 ABR
10066 ABR	10062 ABR	10063 ABR						
10486 ABR	10482 ABR	10483 ABR						
10506 ABR	10502 ABR	10503 ABR						
10076 ABR	10072 ABR	10073 ABR						
10146 ABR	10142 ABR	10143 ABR				-	-	

Accessories for mounting cable trunkings

NEW			L45 Cover - Snap-ON			
W x H (mm)	Profile	Ref.	Top	Joint	Variable Outside Angle	Variable Inside Angle
100 x 50 (1 Cover)		11020 CBR	11025 ABR	11024 ABR	11026 ABR	11022 ABR
155 x 50 (2 Covers)		11030 CBR	11035 ABR	11034 ABR	11036 ABR	11032 ABR
190 x 50 (3 Covers)		11040 CBR	11045 ABR	11044 ABR	11046 ABR	11042 ABR

CBR - White Complet; ABR - White Accessory.

Accessories for mounting cable trunkings

L75 Cover - Universal						
W x H (mm)	Profile	Ref.	Top	Joint	Variable Outside Angle	Variable Inside Angle
110 x 34		10080 RBR	10085 RBR	10084 RBR	10086 RBR	10082 RBR
110 x 50		10090 RBR	10095 RBR	10094 RBR	10096 RBR	10092 RBR
90 x 50		10180 RBR	10185 RBR	10184 RBR	10186 RBR	10182 RBR
180 x 50		10290 RBR	10295 RBR	10294 RBR	10296 RBR	10292 RBR

RBR - White Cable Trunking or Accessory; ABR - White Accessory.





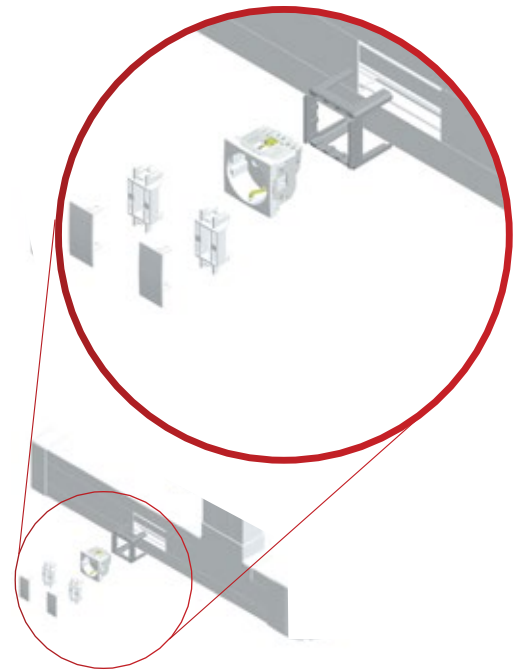





Variable Plane Angle	Derivation	Derivation with Reduction	Divider H34	Cover-Mechanism Clip	Snap-on Trunking 90° Positioner
11023 ABR	11021 ABR	11028 ABR			
11033 ABR	11031 ABR	11038 ABR	10089 R	11991 A	11990 A
11043 ABR	11041 ABR	11048 ABR			











Variable Plane Angle	Derivation	Derivation with Reduction for Cable Trunking 110x50	Derivation with Reduction	Divider H34	Divider H50	Clip for Cable Support
10083 RBR	10081 RBR		10088 ABR	10089 R	—	10987 ABR
10093 RBR	10091 RBR	—	10098 ABR			
10183 RBR	10181 RBR		—	—	10099 R	
10293 RBR	10291 RBR	10298 RBR				

Accessories for mounting cable trunkings

Skirt										
H x W (mm)	Profile	Ref.	Left Top	Right Top	Joint	Variable Outside Angle	Variable Inside Angle	Derivation for 60x16	Lateral Adapter	Clip for Cable Support
110 x 20		10100 CBR	10105 ABR	10108 ABR	10104 ABR	10106 ABR	10102 ABR	10101 ABR	10107 ABR	10109 ABR

CBR - White Complet; ABR - White Accessory.

Accessories for mounting cable trunkings













Floor								
W x H (mm)	Profile	Ref.	Top / Adaptador	Joint	Plane Angle	Adapter for 50x12 Floor Trunking to 40x12,5 Floor Trunking	Adapter for 75x17 Floor Trunking to 60x16 Floor Trunking	Junction Box
50 x 12		10110 CCZ	10115 ACZ	10114 ACZ	10113 ACZ	10117 ACZ	—	10999 ACZ
75 x 17		10120 CCZ	10125 ACZ	10124 ACZ	10123 ACZ	—	10127 ACZ	

CCZ - Grey Complet; ACZ - Grey Accessory.



Mini Cable • Skirt • Floor

Accessories for mounting devices

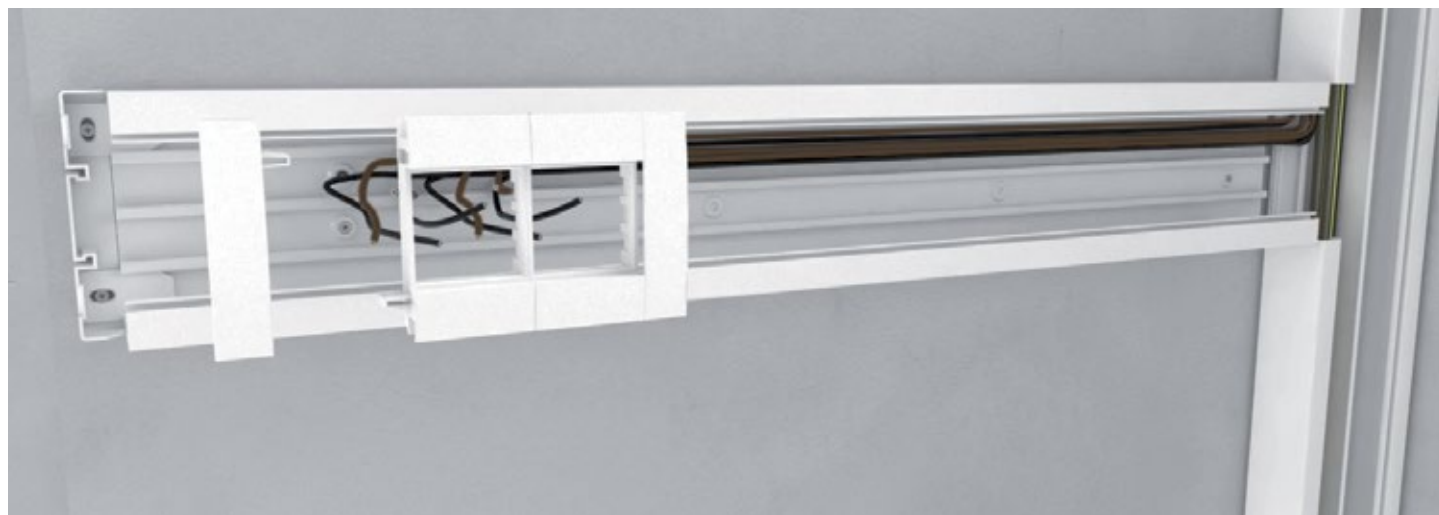

	Series	Designation	Ref.	Colour
	QUADRA	Modular Surface Mounting Box	45996 A	BR AL BM PM
		Cover Plate for Modular Surface Mounting Box	45997 A	
	LATINA	Surface Mounting Box 2 Modules	42985 A	BR AL BM PM
		Surface Mounting Box 3 Modules	41986 A	
		Surface Mounting Box 3+3 Modules	41987 A	
		Surface Mounting Box 4 Modules	41988 A	
		Surface Mounting Box 6 Modules	41989 A	
	LOGUS⁹⁰	Surface Mounting Box	10976 A	BR MF GE PE AL IS PM DU
		Surface Mounting Box Dupla	10994 A	
		Surface Mounting Box Tripla	10995 A	
	APOLO 5000	Surface Mounting Box	10981 A	BR MF
	sirius70	Surface Mounting Box	10975 A	BR MF
	-	Surface Mounting Box Italian Type Mechanisms	10972 A	BR

A - Accessory; BR - White; MF - Ivory; GE - Ice; PE - Pearl; AL - Aluminium; IS - Grey; PM - Matte Black; DU - Golden; BM - Matte White.



L75 Cover - Universal

Accessories for mounting devices

System	Designation	Ref.	Colour
	Q45 Modular Adapter to Trunkings L75 Covers - 2 Modules	10950 A	BR
	Cover Plate Q45 Modular Adapter to Trunkings L75 Covers - 2 Modules	10959 A	
	Adapter Q45 to Trunkings L75 Covers - 2 Modules	10986 A	
	Adapter Q45 to Trunkings L75 Covers - 4 Modules	10952 A	
	Adapter Q45 to Trunkings L75 Covers - 6 Modules	10954 A	
	Flush Mounting Box	10984 A	BR
	Semi-flush Mounting Box	10985 A	
	Flush Mounting Box for Italian Type Mechanisms	10971 A	BR

A - Accessory; BR - White.

Simple Assembly

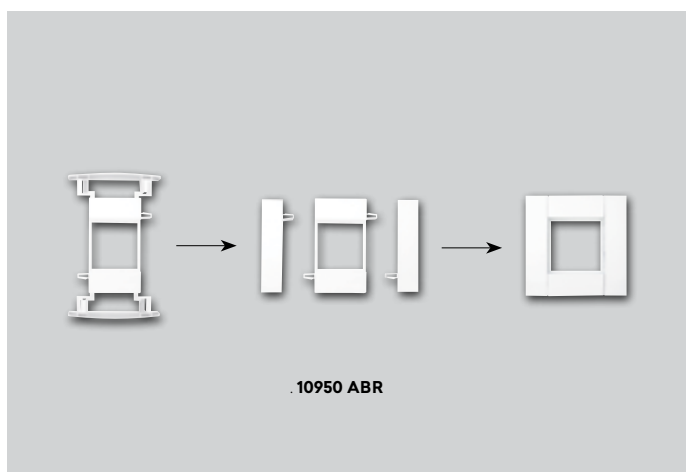

REF. 10950 ABR

Q45 MODULAR ADAPTER TO TRUNKINGS
L75 COVERS

Multiple Assembly

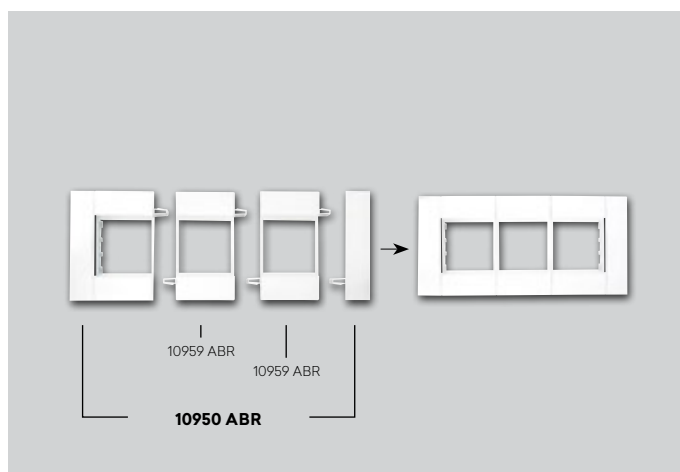

REF. 10950 ABR + 10959 ABR (x2)

COVER PLATE Q45 MODULAR ADAPTER TO TRUNKINGS
L75 COVERS

for protection of cables and pipes







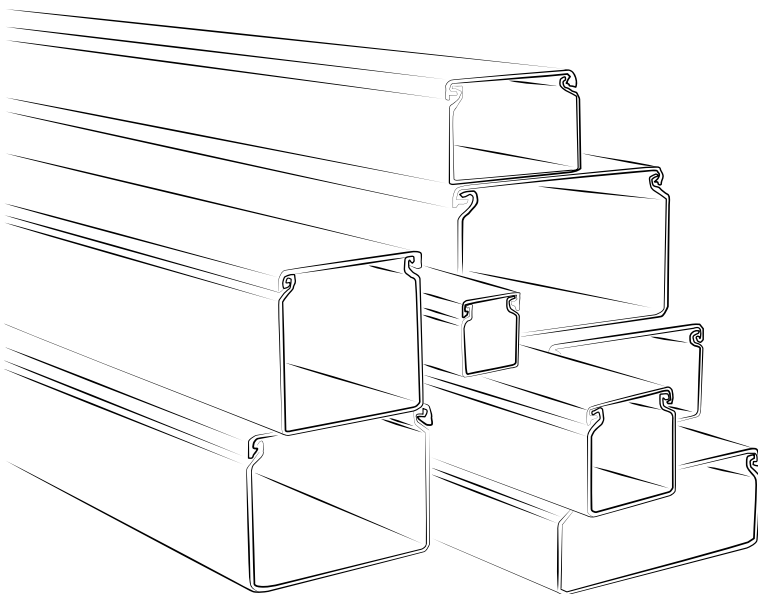













Cable Trunkings for Protection of Cables and Pipes (PVC)

Resistance, viable and versatile solution for canalization systems for installation and protection of cables and tubes for heating, water and air conditioning.

- High impact resistance
- IP44 Protection Degree
- Trunking supplied with protective film.



Accessories for mounting cable trunkings

Protection of Cables and Pipes									
Height (mm)	W x H (mm)	Profile	Ref.	Top	Joint	Variable Outside Angle	Variable Inside Angle	Variable Plane Angle	Derivation
10	10 x 10		13100 CBR	13105 ABR	13104 ABR	13106 ABR (Not Variable)	13102 ABR (Not Variable)	13103 ABR (Not Variable)	13101 ABR
			13100 FBR						
15	15 x 15		13110 CBR	13115 ABR	13114 ABR	13116 ABR (Not Variable)	13112 ABR (Not Variable)	13113 ABR (Not Variable)	13111 ABR
			13110 FBR						
20	20 x 20		13120 CBR	13125 ABR	13124 ABR	13126 ABR	13122 ABR	13123 ABR	13121 ABR
			13120 FBR						
25	25 x 25		13140 CBR	13145 ABR	13144 ABR	13146 ABR	13142 ABR	13143 ABR	13141 ABR
			13140 FBR						
30	25 x 30		13010 CBR	13015 ABR	13014 ABR	13016 ABR	13012 ABR	13013 ABR	13011 ABR
	30 x 30		13150 CBR	13155 ABR	13154 ABR	13156 ABR	13152 ABR	13153 ABR	13151 ABR
			13150 FBR						
40	40 x 40		13020 CBR	13025 ABR	13024 ABR	13026 ABR	13022 ABR	13023 ABR	13021 ABR
	60 x 40		13030 CBR	13035 ABR	13034 ABR	13036 ABR	13032 ABR	13033 ABR	13031 ABR
	60 x 40		13130 CBR						
	80 x 40		13050 CBR	13055 ABR	13054 ABR	13056 ABR	13052 ABR	13053 ABR	13051 ABR
	100 x 40		13070 CBR	13075 ABR	13074 ABR	13076 ABR	13072 ABR	13073 ABR	13071 ABR
60	60 x 60		13040 CBR	13045 ABR	13044 ABR	13046 ABR	13042 ABR	13043 ABR	13041 ABR
	80 x 60		13060 CBR	13065 ABR	13064 ABR	13066 ABR	13062 ABR	13063 ABR	13061 ABR
	100 x 60		13080 CBR	13085 ABR	13084 ABR	13086 ABR	13082 ABR	13083 ABR	13081 ABR

CBR - White Complet; FBR - Adhesive White Complet; ABR - White Accessory.

ETS 14

for panelboards







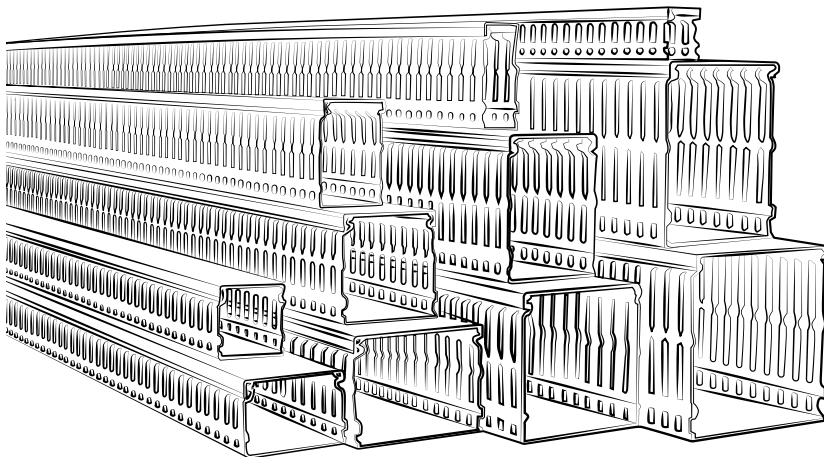











Cable Trunkings for Panelboards (PVC)

Easy to install due to its perforated base, side vanes, the possibility of crossing two trunkings and easy removal of side vanes.

- Available in halogen free version
- Easy crossing of two trunkings
- Flexible side fins
- Side fins easily removable
- No burrs or sharp edges produced



Panelboards

Height (mm)	W x H (mm)	Profile	Ref.
30	25 x 30		14010 CCZ
40	25 x 40		14100 CCZ
	40 x 40		14020 CCZ
	60 x 40		14030 CCZ
	80 x 40		14050 CCZ
	100 x 40		14070 CCZ
60	25 x 60		14090 CCZ
	40 x 60		14110 CCZ
	60 x 60		14040 CCZ
	80 x 60		14060 CCZ
	100 x 60		14080 CCZ
80	40 x 80		14120 CCZ
	60 x 80		14130 CCZ
	80 x 80		14140 CCZ
	100 x 80		14150 CCZ
100	60 x 100		14160 CCZ
	80 x 100		14170 CCZ
	100 x 100		14180 CCZ

CCZ - Grey Complet

Halogen Free: Reinforced Security

EFAPEL provides cable trunkings for numerous solutions, with **halogen free** materials, for high frequency areas where the safety of people and equipment is determinant and indispensable.

In case of fire, and in order to reduce the effects of combustion gases, these materials provide:

- less release of corrosive fumes
- decrease of toxic gases
- reduction of smoke opacity

ETS 10

for
electrical and
telecommunication
installations

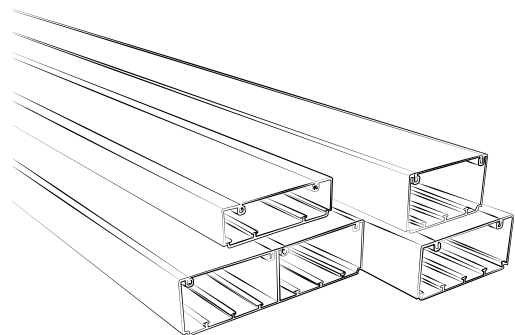

ETS 14



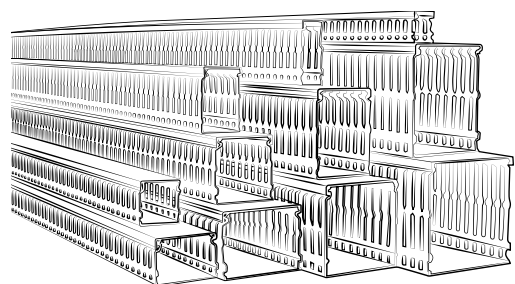







for
panelboards



ETS 10 - Cable Trunkings for Electrical and Telecommunication Installations

Halogen Free

Accessories for mounting cable trunkings





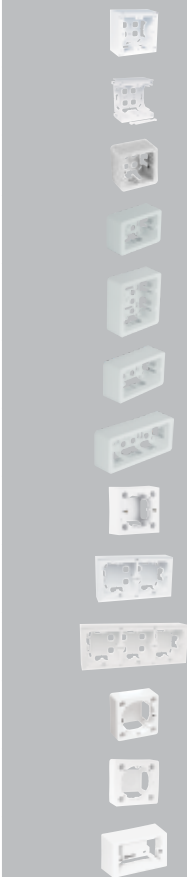

Mini Cable					
W x H (mm)	Profile	Ref.	Top	Joint	Derivation
20 x 12,5		10030 HBR	10035 GBR	10034 GBR	10031 GBR
32 x 12,5		10410 HBR	10405 GBR	10404 GBR	10401 GBR
32 x 12,5		10400 HBR			
32 x 16		10040 HBR	10045 GBR	10044 GBR	10041 GBR
40 x 12,5		10050 HBR	10055 GBR	10054 GBR	10051 GBR
40 x 16		10060 HBR	10065 GBR	10064 GBR	10061 GBR
50 x 20		10500 HBR	10505 GBR	10504 GBR	10501 GBR

HBR - White Complet Halogen Free; ABR - White Accessory; GBR - White Accessory Halogen Free.

Mini Cable Accessories for mounting devices

	Series	Designation	Ref.	Colour
	QUADRA	Modular Surface Mounting Box	45996 A	BR AL BM PM
		Cover Plate for Modular Surface Mounting Box	45997 A	
	LATINA	Surface Mounting Box 2 Modules	42985 A	BR AL BM PM
		Surface Mounting Box 3 Modules	41986 A	
		Surface Mounting Box 3+3 Modules	41987 A	
		Surface Mounting Box 4 Modules	41988 A	
	LOGUS⁹⁰	Surface Mounting Box 6 Modules	41989 A	BR MF GE PE AL IS PM DU
		Surface Mounting Box	10976 A	
		Surface Mounting Box Dupla	10994 A	
	APOLO 5000	Surface Mounting Box Tripla	10995 A	BR MF
		Surface Mounting Box	10981 A	
	sirius70	Surface Mounting Box	10975 A	BR MF
		-	Surface Mounting Box Italian Type Mechanisms	10972 A

A - Accessory; BR - White; MF - Ivory; GE - Ice; PE - Pearl; AL - Aluminium; IS - Grey; PM - Matte Black; DU - Golden; BM - Matte White.





					
Variable Outside Angle	Variable Inside Angle	Variable Plane Angle	Junction Box 80x80x20	Junction Box 80x80x30	Junction Box 110x110x50
10036 GBR	10032 GBR	10033 GBR	10991 ABR	10998 ABR	10993 ABR
10406 GBR	10402 GBR	10403 GBR			
10046 GBR	10042 GBR	10043 GBR			
10056 GBR	10052 GBR	10053 GBR			
10066 GBR	10062 GBR	10063 GBR			
10506 GBR	10502 GBR	10503 GBR			





ETS 10 - Cable Trunkings for Electrical and Telecommunication Installations

Halogen Free

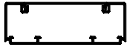
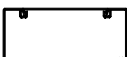
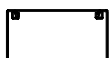
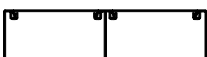
Accessories for mounting cable trunkings

L75 Cover - Universal						
W x H (mm)	Profile	Ref.	Top	Joint	Variable Outside Angle	Variable Inside Angle
110 x 34		10080 HBR	10085 GBR	10084 GBR	10086 GBR	10082 GBR
110 x 50		10090 HBR	10095 GBR	10094 GBR	10096 GBR	10092 GBR
90 x 50		10180 HBR	10185 GBR	10184 GBR	10186 GBR	10182 GBR
180 x 50		10290 HBR	10295 GBR	10294 GBR	10296 GBR	10292 GBR

HBR - White Complet Halogen Free; G - Accessory Halogen Free.

L75 Cover - Universal		Accessories for mounting devices		
System	Designation	Ref.	Colour	
	Q45 Modular Adapter to Trunkings L75 Covers - 2 Modules	10950 A	BR	
	Cover Plate Q45 Modular Adapter to Trunkings L75 Covers - 2 Modules	10959 A		
	Adapter Q45 to Trunkings L75 Covers - 2 Modules	10986 A		
	Adapter Q45 to Trunkings L75 Covers - 4 Modules	10952 A		
	Adapter Q45 to Trunkings L75 Covers - 6 Modules	10954 A		
	Flush Mounting Box	10984 G	BR	
	Semi-flush Mounting Box	10985 G		

A - Accessory; G - Accessory Halogen Free; BR - White.

Variable Plane Angle	Derivation	Derivation with Reduction for Trunking 110x50	Derivation with Reduction	Divider H34	Divider H50	Clip for Cable Support
10083 GBR	10081 GBR		10088 GBR	10089 G	—	
10093 GBR	10091 GBR	—	10098 GBR			
10183 GBR	10181 GBR			—	10099 G	10987 GBR
10293 GBR	10291 GBR	10298 GBR	—			

Simple Assembly

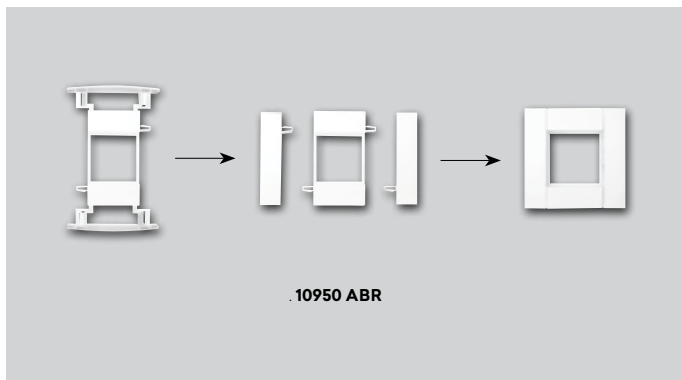

Multiple Assembly

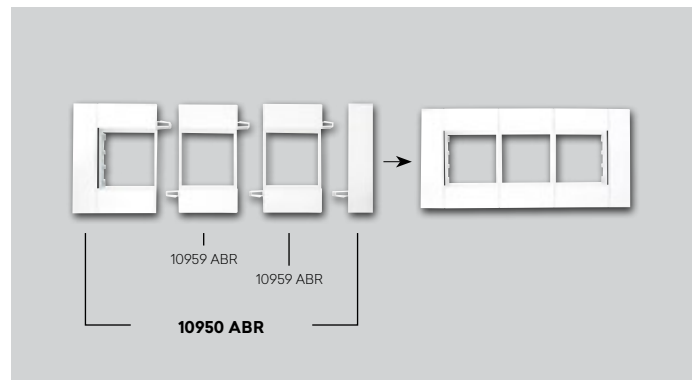

REF. 10950 ABR

Q45 MODULAR ADAPTER TO TRUNKINGS
L75 COVERS



















REF. 10950 ABR + 10959 ABR (x2)

COVER PLATE Q45 MODULAR ADAPTER TO TRUNKINGS
L75 COVERS

ABR - White Accessory.

Halogen Free

Panelboards

Height (mm)	W x H (mm)	Profile	Ref.
30	25 x 30		14010 HCZ
40	25 x 40		14100 HCZ
	40 x 40		14020 HCZ
	60 x 40		14030 HCZ
	80 x 40		14050 HCZ
	100 x 40		14070 HCZ
60	25 x 60		14090 HCZ
	40 x 60		14110 HCZ
	60 x 60		14040 HCZ
	80 x 60		14060 HCZ
	100 x 60		14080 HCZ
80	40 x 80		14120 HCZ
	60 x 80		14130 HCZ
	80 x 80		14140 HCZ
	100 x 80		14150 HCZ
100	60 x 100		14160 HCZ
	80 x 100		14170 HCZ
	100 x 100		14180 HCZ

HCZ - Grey Complet Halogen Free.

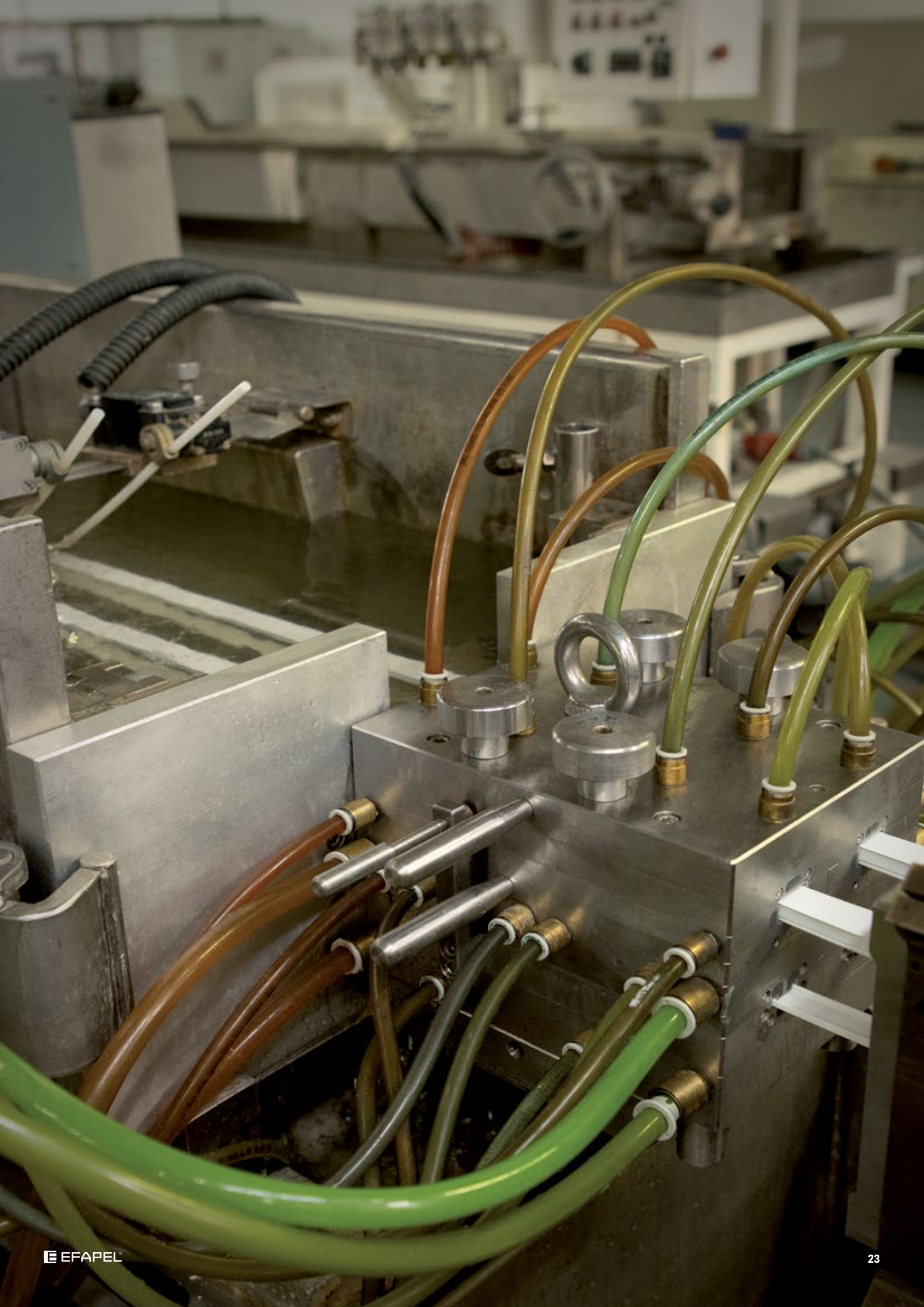

RoHS

By complying with the ROHS directive, EFAPEL gives priority to the safety of people and the environment. Contributes to sustainable **construction by limiting the use of substances considered hazardous by the EU** (as lead, mercury among others).

All the cable-trunkings and the respective Accessories manufactured by EFAPEL are according the specifications of Directive RoHS 2011/65/UE (including the addendum 2015/863), maintaining the technical characteristics and providing the same features as the products.

Contents

Technical Information

- Selection Guide	28
ETS 10 - Cable Trunkings for Electrical and Telecommunication Installations	28
ETS 13 - Cable Trunkings for Protection of Cables and Pipes	33
ETS 14 - Cable Trunkings for Panelboards	34
- Table of Cables Criteria for Cable Trunkings Selection	36
- Classification and Standards	37

Mini Cable



W x H (mm)	Profile	Ref.
12 x 7		10010 CBR 10010 FBR
16 x 10		10020 CBR 10020 FBR
20 x 12,5		10030 CBR 10030 FBR 10030 HBR
25 x 16 NEW		10450 CBR 10450 FBR
32 x 12,5		10410 CBR 10410 FBR 10410 HBR
		10400 CBR 10400 FBR 10400 HBR
		10040 CBR 10040 FBR 10040 HBR
		10050 CBR 10050 FBR 10050 HBR
40 x 12,5		10150 CBR 10150 FBR
40 x 16		10060 CBR 10060 FBR 10060 HBR
		10160 CBR 10160 FBR
40 x 25 NEW		10480 CBR
50 x 20		10500 CBR 10500 HBR
		10510 CBR
		10520 CBR
60 x 16		10070 CBR
		10170 CBR
75 x 20		10140 CBR

Trunkings Characteristics

Internal Dim. (mm)	Length (m)	Internal Section (S) (mm ²)	Available Section (Su) (S/1,4) (mm ²)
10x5	2,10	61	44
14x8	2,10	121	86
18x10	2,10	182	130
23x14	2,10	290	207
30x10	2,10	1 145 2 145	104 104
		310	221
30x14	2,10	401	286
38x9	2,10	1 179 2 179	128 128
		394	282
38x14	2,10	1 232 2 232	166 166
		514	368
37x22	2,10	805	575
47x17	2,10	836	597
		1 553 2 256	395 183
		1 256 2 270 3 256	183 193 183
57x14	2,10	1 228 2 246 3 228	163 176 163
		787	563
72x18	2,10	1 325 2 463 3 325	232 331 232

Isolated Cables Capacity

ø Max Available (mm)	Max. Nr. Conductors H07 V-U			
	1,5 mm ²	2,5 mm ²	4 mm ²	6 mm ²
5	5	4	3	2
8	11	7	6	4
10	16	11	9	6
14	25	18	14	11
10 10	13 13	9 9	7 7	5 5
10 10	28	18	15	11
14	36	25	20	15
9 9	16 16	11 11	9 9	6 6
9	36	24	19	14
14 14	21 21	14 14	11 11	8 8
14	47	32	25	19
22	71	50	39	30
17	75	50	40	30
17 17	49 23	33 15	26 12	20 9
17 17 17	23 24 23	15 16 15	12 13 12	9 10 9
14 14 14	20 22 20	14 15 14	11 12 11	8 9 8
14	72	48	39	29
17 17 17	29 42 29	20 28 20	16 23 16	12 17 12

CBR - White Complet; FBR - Adhesive White Complet; HBR - White Complet Halogen Free.

Halogen Free

L45 Cover - Snap-ON NEW			Trunkings Characteristics				Isolated Cables Capacity				
RoHS IP44			Internal Dim.	Length	Internal Section (S)	Available Section (Su)	∅ Max Available	Max. Nr. Conductors H07 V-U			
W x H (mm)	Profile	Ref.	(mm)	(m)	(mm ²)	(S/1,4) (mm ²)	(mm)	1,5 mm ²	2,5 mm ²	4 mm ²	6 mm ²
100 x 50		11020 CBR	96x47	2,00	2155	1539	32	191	135	106	81
	① 493 ② 1058 ③ 493				352 756 352	20 32 20					
155 x 50		11030 CBR	75x47 75x47	2,00	① 1672 ② 1672	1194 1194	32 32	148 148	105 105	82 82	63 63
	① 357 ② 1259 ③ 1259 ④ 357				255 899 899 255	16 32 32 16					
190 x 50		11040 CBR	63x47 57x47 63x47	2,00	① 1325 ② 1214 ③ 1325	946 867 946	32 32 32	117 107 117	83 76 83	65 59 65	50 46 50

CBR - White Complet

NOTE: 45 mm (L45) wide cover

L75 Cover - Universal



W x H (mm)	Profile	Ref.
90 x 50		10180 RBR
		10180 HBR
		10180 RBR
		10180 HBR
		10180 RBR
		10180 HBR
90 x 50 with Flush Mounting Box		10180 RBR 10180 HBR
90 x 50 with Semi-flush Mounting Box		10180 RBR 10180 HBR

Trunkings Characteristics

Internal Dim. (mm)	Length (m)	Internal Section (S) (mm ²)	Available Section (Su) (S/1,4) (mm ²)
86x47	2,00	3909	2792
		1 1890 2 1890	1350 1350
		1 725 2 2202 3 725	518 1572 518
		2109 (a)	1506
		2686 (a)	1918

Isolated Cables Capacity

ø Max Available (mm)	Max. Nr. Conductors H07 V-U			
	1,5 mm ²	2,5 mm ²	4 mm ²	6 mm ²
45	349	233	186	140
40 40	169 169	113 113	90 90	68 68
25 30 25	65 197 65	43 131 43	35 105 35	26 79 26
—	188	126	100	75
—	240	160	128	96

180 x 50		10290 RBR
		10290 HBR
		10290 RBR
		10290 HBR
		10290 RBR
		10290 HBR
180 x 50 with Flush Mounting Box		10290 RBR 10290 HBR
180 x 50 with Semi-flush Mounting Box		10290 RBR 10290 HBR

87x47 87x47	2,00	3960	2829
		1 1946 2 1885	1390 1347
		1 781 2 2202 3 720	558 1572 514
		2160 (a)	1543
		2737 (a)	1955

45	354	236	189	141
45 45	174 168	116 112	93 90	70 67
45 45 45	70 197 64	47 131 43	37 105 34	28 79 26
—	193	129	103	77
—	244	163	130	98

RBR - White Cable Trunking or Accessory; HBR - White Complet Halogen Free.
 (a) - Section available with the largest mechanisms installed.
 NOTE: 75 mm (L75) wide cover.



L75 Cover - Universal



W x H (mm)	Profile	Ref.
110 x 34		10080 RBR
		10080 HBR
		10080 RBR
		10080 HBR
110 x 34 with Flush Mounting Box		10080 RBR
		10080 HBR
110 x 34 with Semi-flush Mounting Box		10080 RBR
		10080 HBR

Trunkings Characteristics			
Internal Dim.	Length	Internal Section (S)	Available Section (Su)
(mm)	(m)	(mm ²)	(S/1,4) (mm ²)
106x31	2,00	3115	2225
		① 896 ② 1148 ③ 896	640 820 640
		1315 (a)	969
		1892 (a)	1351

Isolated Cables Capacity				
∅ Max Available	Max. Nr. Conductors H07 V-U			
(mm)	1,5 mm ²	2,5 mm ²	4 mm ²	6 mm ²
28	283	192	154	115
24 27 24	81 104 81	55 71 55	44 57 44	33 42 33
—	119	81	65	48
—	172	116	93	69

110 x 50		10090 RBR
		10090 HBR
		10090 RBR
		10090 HBR
110 x 50 with Flush Mounting Box		10090 RBR
		10090 HBR
110 x 50 with Semi-flush Mounting Box		10090 RBR
		10090 HBR

106x47	2,00	4834	3453
		① 2353 ② 2353	1680 1680
		① 1188 ② 2202 ③ 1188	848 1572 848
		3034 (a)	2167
		3611 (a)	2579

43	434	294	235	176
41 41	214 210	145 142	116 114	86 85
31 38 31	126 161 126	86 109 86	69 87 69	51 65 51
—	270	183	146	109
—	322	219	175	130

RBR - White Cable Trunking or Accessory; HBR - White Complet Halogen Free.
 (a) - Section available with the largest mechanisms installed.
 NOTE: 75 mm (L75) wide cover.

Halogen Free

Skirt



H x W (mm)	Profile	Ref.
110 x 20		10100 CBR

CBR - White Complet.

Trunkings Characteristics

Internal Dim.	Length	Internal Section (S)	Available Section (Su)
(mm)	(m)	(mm ²)	(S/1,4) (mm ²)
104x17	2,00	1 330	236
		2 420	301
		3 436	312

Isolated Cables Capacity

ø Max Available	Max. Nr. Conductors H07 V-U			
	1,5 mm ²	2,5 mm ²	4 mm ²	6 mm ²
14	30	20	16	12
16	38	26	21	15
17	40	27	21	16

Floor



W x H (mm)	Profile	Ref.
50 x 12		10110 CCZ
75 x 17		10120 CCZ















CBR - Grey Complet.

Trunkings Characteristics

Internal Dim.	Length	Internal Section (S)	Available Section (Su)
(mm)	(m)	(mm ²)	(S/1,4) (mm ²)
30x9	2,00	1 47	34
		2 148	106
		3 47	34
60x14	2,00	1 198	142
		2 238	170
		3 198	142

Isolated Cables Capacity

ø Max Available	Max. Nr. Conductors H07 V-U			
	1,5 mm ²	2,5 mm ²	4 mm ²	6 mm ²
6	4	3	2	1
9	13	9	7	5
6	4	3	2	1
11	18	12	10	7
14	21	14	11	8
11	18	12	10	7

Protection of Cables and Pipes			Trunkings Characteristics				Cables, Pipes and Conductors Capacity				
 			Internal Dim.	Length	Internal Section (S)	Available Section (Su)	∅ Max Available	Max. Nr. Conductors H07 V-U			
			(mm)	(m)	(mm ²)	(S/1,4) (mm ²)	(mm)	1,5 mm ²	2,5 mm ²	4 mm ²	6 mm ²
W x H (mm)	Profile	Ref.									
10 x 10		13100 CBR	8x8	2,00	50	36	6	4	3	2	1
		13100 FBR									
15 x 15		13110 CBR	13x13	2,00	151	108	11	12	8	6	5
		13110 FBR									
20 x 20		13120 CBR	18x18	2,00	280	200	15	22	15	12	9
		13120 FBR									
25 x 25		13140 CBR	22x22	2,00	439	314	19	46	28	22	17
		13140 FBR									
25 x 30		13010 CBR	22x27	2,00	530	379	20	48	32	26	19
30 x 30		13150 CBR	27x27	2,00	670	479	25	52	35	28	21
		13150 FBR									
40 x 40		13020 CBR	37x37	2,00	1281	915	35	116	79	63	47
60 x 40		13030 CBR	56x37	2,00	1974	1410	35	180	122	97	73
		13130 CBR	① 36x37 ② 18x37	2,00	1264 619	903 442	30 10	113 55	77 37	61 30	46 22
80 x 40		13050 CBR	73x36	2,00	2668	1906	35	243	164	132	98
100 x 40		13070 CBR	96x36	2,00	3352	2395	35	305	207	166	123
60 x 60		13040 CBR	56x56	2,00	3102	2216	55	282	191	153	114
80 x 60		13060 CBR	76x56	2,00	4192	2994	55	382	259	207	154
100 x 60		13080 CBR	96x56	2,00	5272	3766	55	480	325	260	194

CBR - White Complet; FBR - Adhesive White Complet.

Panelboards				Trunkings Characteristics				Cables, Pipes and Conductors Capacity				
Height (mm)	W x H (mm)	Profile	Ref.	Internal Dim.	Length	Internal Section (S)	Available Section (Su)	ø Max Available (mm)	Max. Nr. Conductors H07 V-U			
				(mm)	(m)	(mm ²)	(S/1,4) (mm ²)		1,5 mm ²	2,5 mm ²	4 mm ²	6 mm ²
30	25 x 30		14010 CCZ	22x27	2,00	535	382	20	43	29	23	17
			14010 HCZ									
40	25 x 40		14100 CCZ	22x37	2,00	753	538	20	66	45	36	27
			14100 HCZ									
	40 x 40		14020 CCZ	37x37	2,00	1282	916	35	105	72	57	43
			14020 HCZ									
	60 x 40		14030 CCZ	57x37	2,00	2014	1439	35	163	110	88	66
			14030 HCZ									
	80 x 40		14050 CCZ	77x37	2,00	2763	1974	35	221	150	120	90
			14050 HCZ									
100 x 40		14070 CCZ	97x37	2,00	3509	2506	35	279	189	152	113	
		14070 HCZ										
60	25 x 60		14090 CCZ	22x57	2,00	1194	853	20	111	76	60	45
			14090 HCZ									
	40 x 60		14110 CCZ	37x57	2,00	2024	1446	35	182	123	99	74
			14110 HCZ									
	60 x 60		14040 CCZ	57x57	2,00	3155	2254	55	283	192	154	115
			14040 HCZ									
	80 x 60		14060 CCZ	77x57	2,00	4309	3078	55	385	261	209	156
			14060 HCZ									
100 x 60		14080 CCZ	97x57	2,00	5458	3899	55	486	329	264	197	
		14080 HCZ										
80	40 x 80		14120 CCZ	37x77	2,00	2763	1974	35	260	176	141	105
			14120 HCZ									
	60 x 80		14130 CCZ	56x77	2,00	4255	3039	55	401	272	218	162
			14130 HCZ									
	80 x 80		14140 CCZ	76x77	2,00	5791	4136	75	545	369	296	221
			14140 HCZ									
100 x 80		14150 CCZ	96x77	2,00	7344	5246	75	689	467	374	279	
		14150 HCZ										
100	60 x 100		14160 CCZ	56x96	2,00	5290	3779	55	512	347	278	207
			14160 HCZ									
	80 x 100		14170 CCZ	76x96	2,00	7218	5156	75	697	473	379	282
			14170 HCZ									
	100 x 100		14180 CCZ	96x96	2,00	9155	6539	95	883	599	480	358
			14180 HCZ									

CCZ - Grey Complet; HCZ - Grey Complet Halogen Free.

Halogen Free

Drilling Scheme for the Base and Lateral Sides of the different Trunking sizes (mm)

Base Perforation (mm)

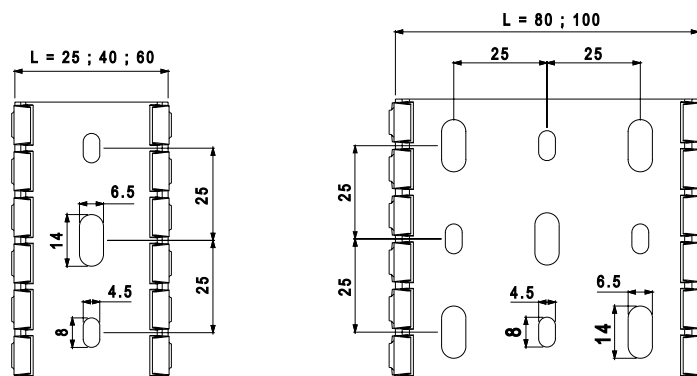

Lateral Perforation (mm)

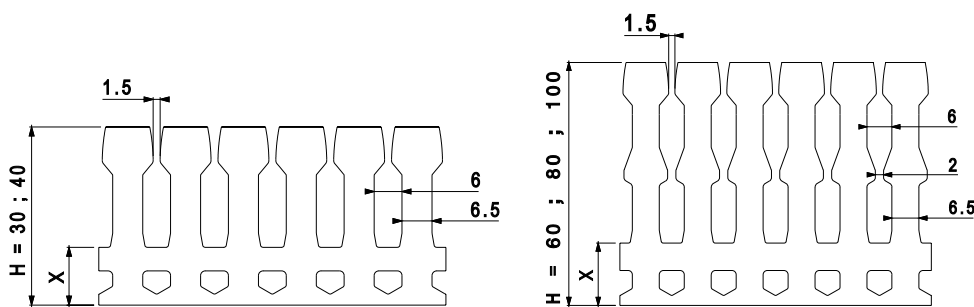

H	X
30	9
40	12,5
60	15
80	18
100	20

Table of Cables

Power Cables

Diameter and cross sections of commonly used cables
(Sizes may vary depending on manufacturer)

IT / Telephone Cables

Diameter and cross sections of some commonly used IT cables: UTP, STP, FTP, Coaxial.
(Sizes may vary depending on manufacturer)

Type of Cable	Nominal Section (mm)	Diameter (mm)	Section (mm ²)	Type of Cable	Diameter (mm)	Section (mm ²)
H05 VV-F	2x0,75	7,6	58	4P UTP Cat. 5e Cable	6,2	37,5
H05 VV-F	2x1	8,0	64	4P FTP Cat. 5e Cable	6,9	47,2
H05 VV-F	2x1,5	9,0	81	4P UTP Cat. 6 Cable	7,6	57
H05 VV-F	2x2,5	11,0	121	4P FTP Cat. 6 Cable	8,3	68
H05 VV-F	3 G 0,75	8,0	64	RG 59 Cable Coaxial	6,2	38,4
H05 VV-F	3 G 1	8,4	71	RG 58 Cable Coaxial	5	25
H05 VV-F	3 G 1,5	9,8	96	RG 11 Cable Coaxial	10,5	110,3
H05 VV-F	3 G 2,5	12,0	144	RG 8 Cable Coaxial	10,3	106,1
H07 V-U	1x1,5	2,8	7,84	RG 7 Cable Coaxial	8,1	65,6
H07 V-U	1x2,5	3,4	11,56	RG 6 Cable Coaxial	7	49
H07 V-U	1x4	3,8	14,44	TVHV 1x2x0,5 Cable	4,3	18,5
H07 V-U	1x6	4,4	19,36	TVHV 2x2x0,5 Cable	5,0	25
H07 V-K	1x1,5	3,5	12	TVHV 3x2x0,5 Cable	5,7	32,5
H07 V-K	1x2,5	4,2	18	TVHV 6x2x0,5 Cable	6,5	42,3
H07 V-K	1x4	4,8	23	TVHV 10x2x0,5 Cable	7,8	60,8
H07 V-K	1x6	6,3	40	TVHV 15x2x0,5 Cable	8,7	75,7
H07 V-K	1x10	7,6	58	TVHV 20x2x0,5 Cable	9,7	94,1
VV-0,6/1 KV	3x16+10	20,7	428	TVHV 30x2x0,5 Cable	12,0	144
VV-0,6/1 KV	3x25+16	23,0	529	TVHV 40x2x0,5 Cable	13,5	182,3
VV-0,6/1 KV	3x35+16	25,0	625	TVHV 50x2x0,5 Cable	15,0	225
VV-0,6/1 KV	4 G 1,5	11,4	130	TVHV 100x2x0,5 Cable	20,0	400

Trunking Selection Criteria

Examples for a Typical Installation:

Cables to install

Type of Cable	Quantity (Q)	Nominal Section (S)	Outside Diameter (D) (mm)	Unitary Section (SU) (SU= DxD)	Total Section (ST) (mm ²) (SUxQ)
H07 V-U	20	1x4	3,8	14,44	288,8
H07 V-U	15	1x6	4,4	19,36	290,4
H07 V-U	10	1x2,5	3,4	11,56	115,6
H07 V-U	10	1x4	3,8	14,44	144,4
Total Section of Cables (St)					839,2 mm²
Minimum Trunking Size = Total Section of Cables (St) x K = 839,2 x 1,4 =					1174,88 mm²

Typical K values to ensure better ventilation, crossovers and possible expansion:

K = Filling coefficient

K = 1,4 for LV Cables

K = 1,3 for IT and Telephone Cables

K = 1,2 para Ducting

You may opt for the following EFAPEL trunking:

Trunking			
Ref.	Designation	Internal Section (mm ²)	Available Section (mm ²)
10080 HBR	Trunking 110x34	3115	2225
14030 CBR	Trunking 60x40	2014	1439

EN 50085-2-1 Standard

Section 6	Classification	Mini Cable Skirt		Distribution		
6.2	Resistance to impact for installation and application	12x7	0,5 J	5 J	Trunking	Accessories
		110x20	1 J			
		16x10 / 20x12,5 / 25x16 / 32x12,5 / 32x16 / 40x12,5 / 40x16 / 40x25 / 50x20 / 60x16 / 75x20	2 J			
		20x12,5 / 32x12,5 / 32x16 / 40x12,5 / 40x16 / 50x20	2 J			
6.3	Minimum stock and transport temperature	-25 °C		-45 °C		
6.3	Minimum installation and operation temperature	-5 °C		-25 °C		
6.3	Maximum operating temperature	60 °C		60 °C		
6.4	Flame propagation resistance	Non-flame propagating				
6.5	Electrical continuity	Without electrical continuity				
6.6	Electrical insulation characteristics	With electrical insulation				
6.7	Protection Degree provided by enclosure	IP44				
6.8	Protection against corrosive or polluting substances	With medium protection outside and inside				
6.9	Access system and retention of the cover	The cover can only be opened with a tool				
6.10	Electrical protective separation	With and without electrical protective partition (divider)				
6.101	Intended installation positions	Surface mounted, fixed on the wall or on the ceiling				
6.102	Prevention of contact between liquids and insulated conductors and live parts parts in the case of mounted on the skirting position and on wet floor	Not declared				
6.103	Type	3 (installation)				
	Glow wire test	-		Trunking	Trunking Accessories	System Accessories
				1000 °C	1000 °C	650 °C
	Rated voltage	500 V ~		1000 V ~		
	IEC 60884-1 – NP 1260 Fixation of Low Voltage Devices - Extraction resistance test	-		Declared extraction force: 90 N 1,5x90 = 135 N		

Halogen Free

ASTM G-53 Standard

UV Resistant

Accelerated Ageing Chamber Test	Resistant
UV Test	80 h - without changes
Condensation test	40 h - without changes



RoHS - All the Cable-trunkings and the respective Accessories manufactured by EFAPEL are according the specifications of Directive RoHS 2011/65/EU (including the addendum 2015/863) that restricts the use of certain hazardous substances like lead, mercury, cadmium, hexavalent chromium, polybrominated biphenyls (PBB), polybrominated diphenyl ethers (PBDE), Bis (2-ethylhexyl) phthalate (DEHP), butyl benzyl phthalate (BBP), dibutyl phthalate (DBP), diisobutyl phthalate (DIBP).

Norma EN 50085-2-2

Section 6	Classification	Floor Cable Trunkings
6.2	Resistance to impact for installation and application	2 J
6.3	Minimum stock and transport temperature	-25 °C
6.3	Minimum installation and operation temperature	-5 °C
6.3	Maximum operating temperature	60 °C
6.4	Flame propagation resistance	Non-flame propagating
6.5	Electrical continuity	Without electrical continuity
6.6	Electrical insulation characteristics	With electrical insulation
6.7	Protection Degree provided by enclosure	IP44
6.8	Protection against corrosive or polluting substances	With medium protection outside and inside
6.9	Access system and retention of the cover	The cover can only be opened with a tool
6.10	Electrical protective separation	With electrical protective partition (divider)
6.101.3	Floor treatment	CTS/CDS for wet-treatment of floor when the service unit is in use
6.102	Resistance to vertical load applied through small surface area	500 N
6.103	Resistance to vertical load applied through large surface area	2000 N
	Rated voltage	500 V ~

ASTM G-53 Standard

UV Resistant

Accelerated Ageing Chamber Test	Resistant
UV Test	80 h - without changes
Condensation test	40 h - without changes



RoHS - All the Cable-trunkings and the respective Accessories manufactured by EFAPEL are according the specifications of Directive RoHS 2011/65/EU (including the addendum 2015/863) that restricts the use of certain hazardous substances like lead, mercury, cadmium, hexavalent chromium, polybrominated biphenyls (PBB), polybrominated diphenyl ethers (PBDE), Bis (2-ethylhexyl) phthalate (DEHP), butyl benzyl phthalate (BBP), dibutyl phthalate (DBP), diisobutyl phthalate (DIBP).

EN 50085-2-1 Standard

Section 6	Classification	Trunkings for L45 Cover - Snap-ON		
6.2	Resistance to impact for installation and application	2 J		
6.3	Minimum stock and transport temperature	-45 °C		
6.3	Minimum installation and operation temperature	-25 °C		
6.3	Maximum operating temperature	60 °C		
6.4	Flame propagation resistance	Non-flame propagating		
6.5	Electrical continuity	Without electrical continuity		
6.6	Electrical insulation characteristics	With electrical insulation		
6.7	Protection Degree provided by enclosure	IP44		
6.8	Protection against corrosive or polluting substances	With medium protection outside and inside		
6.9	Access system and retention of the cover	The cover can only be opened with a tool		
6.10	Electrical protective separation	With electrical protective partition (divider)		
6.101	Intended installation positions	Surface mounted, fixed on the wall or on the ceiling		
6.102	Prevention of contact between liquids and insulated conductors and live parts parts in the case of mounted on the skirting position and on wet floor	Not declared		
6.103	Type	3 (installation)		
	Glow wire test	Trunking	Trunking Accessories (derivation, angles, joint and top)	System Accessories (component with supplementary function e.g. sockets and their fixing accessories)
		1000 °C	1000 °C	650 °C
	Rated voltage	1000 V ~		
	IEC 60884-1 - NP 1260 Fixation of Low Voltage Devices - Extraction resistance test	Declared extraction force: 90 N 1,5x90 = 135 N		

ASTM G-53 Standard

UV Resistant

Accelerated Ageing Chamber Test	Resistant
UV Test	80 h - without changes
Condensation test	40 h - without changes



RoHS - All the Cable-trunkings and the respective Accessories manufactured by EFAPEL are according the specifications of Directive RoHS 2011/65/EU (including the addendum 2015/863) that restricts the use of certain hazardous substances like lead, mercury, cadmium, hexavalent chromium, polybrominated biphenyls (PBB), polybrominated diphenyl ethers (PBDE), Bis (2-ethylhexyl) phthalate (DEHP), butyl benzyl phthalate (BBP), dibutyl phthalate (DBP), diisobutyl phthalate (DIBP).

EN 50085-2-1 Standard

Section 6	Classification	Cable Trunkings for Protection of Cables and Pipes			
		Trunking		Accessories	
6.2	Resistance to impact for installation and application	10x10 / 15x15	1 J	10x10 / 15x15	0,5 J
		20x20 / 25x25 / 25x30 / 30x30	2 J	20x20 / 25x25 / 25x30 / 30x30 / 40x40 / 60x40 / 60x60 / 80x40 / 80x60 / 100x40 / 100x60	2 J
		40x40 / 60x40 / 60x60 / 80x40 / 80x60 / 100x40 / 100x60	5 J		
6.3	Minimum stock and transport temperature	-25 °C			
6.3	Minimum installation and operation temperature	-5 °C			
6.3	Maximum operating temperature	60 °C			
6.4	Flame propagation resistance	Non-flame propagating			
6.5	Electrical continuity	Without electrical continuity			
6.6	Electrical insulation characteristics	With electrical insulation			
6.7	Protection Degree provided by enclosure	IP44			
6.8	Protection against corrosive or polluting substances	With medium protection outside and inside			
6.9	Access system and retention of the cover	The cover can only be opened with a tool			
6.10	Electrical protective separation	With and without electrical protective partition (divider)			
6.101	Intended installation positions	Surface mounted, fixed on the wall or on the ceiling			
6.102	Prevention of contact between liquids and insulated conductors and live parts in the case of mounted on the skirting position and on wet floor	Not declared			
6.103	Type	2 (Distribution)			
	Rated voltage	500 V ~			

ASTM G-53 Standard

UV Resistant

Accelerated Ageing Chamber Test	Resistant
UV Test	80 h - without changes
Condensation test	40 h - without changes



RoHS - All the Cable-trunkings and the respective Accessories manufactured by EFAPEL are according the specifications of Directive RoHS 2011/65/EU (including the addendum 2015/863) that restricts the use of certain hazardous substances like lead, mercury, cadmium, hexavalent chromium, polybrominated biphenyls (PBB), polybrominated diphenyl ethers (PBDE), Bis (2-ethylhexyl) phthalate (DEHP), butyl benzyl phthalate (BBP), dibutyl phthalate (DBP), diisobutyl phthalate (DIBP).

EN 50085-2-3 Standard

Section 6	Classification	Cable Trunkings for Panelboards
6.3	Minimum stock and transport temperature	-25 °C
6.3	Maximum operating temperature	60 °C
6.4	Flame propagation resistance	Non-flame propagating
6.101	Intended installation positions	Mounted on vertical or horizontal surface except in cover down position

ASTM G-53 Standard

UV Resistant

Accelerated Ageing Chamber Test	Resistant
UV Test	80 h - without changes
Condensation test	40 h - without changes

EN 50085-2-3 Standard

Section 6	Classification	Cable Trunkings for Panelboards
6.3	Minimum stock and transport temperature	-25 °C
6.3	Maximum operating temperature	60 °C
6.4	Flame propagation resistance	Non-flame propagating
6.101	Intended installation positions	Mounted on vertical or horizontal surface except in cover down position

ASTM G-53 Standard

UV Resistant

Accelerated Ageing Chamber Test	Resistant
UV Test	80 h - without changes
Condensation test	40 h - without changes

Halogen Free



RoHS - All the Cable-trunkings and the respective Accessories manufactured by EFAPEL are according the specifications of Directive RoHS 2011/65/EU (including the addendum 2015/863) that restricts the use of certain hazardous substances like lead, mercury, cadmium, hexavalent chromium, polybrominated biphenyls (PBB), polybrominated diphenyl ethers (PBDE), Bis (2-ethylhexyl) phthalate (DEHP), butyl benzyl phthalate (BBP), dibutyl phthalate (DBP), diisobutyl phthalate (DIBP).

Protection Index (IK) - EN 50102 Standard

ETS 10 - Cable Trunkings for Electrical and Telecommunication Installations

Ref.	Outside Dimensions (mm)	Protection Against the Mechanical Shocks - IK	
Mini Cable		Trunkings	Accessories
10010	12x7	05	05
10020	16x10	07	07
10030	20x12,5	07	07
10450	25x16	08	07
10400 10410	32x12,5	07	07
10040	32x16	08	07
10050 10150	40x12,5	07	07
10060 10160	40x16	08	07
10480	40x25	07	07
10500 10510 10520	50x20	07	07
10070 10170	60x16	08	07
10140	75x20	07	07
Snap-ON L45		Trunkings	Accessories
11020	100x50	08	07
11030	155x50		
11040	190x50		
Universal L75		Trunkings	Accessories
10080	110x34	09	08
10090	110x50		
10180	90x50		
10290	180x50		
Skirt		Trunkings	Accessories
10100	110x20	05	05
Floor		Trunkings	Accessories
10110	50x12	07	06
10120	75x17		

Halogen Free

Protection Index (IK) - EN 50102 Standard

ETS 13 - Cable Trunkings for Protection of Cables and Pipes

Ref.	Outside Dimensions (mm)	Protection Against the Mechanical Shocks - IK	
		Trunkings	Accessories
13100	10x10	06	06
13100	15x15		
13120	20x20	07	07
13140	25x25		
13010	25x30	08	07
13150	30x30		
13020	40x40		
13030	60x40		
13040	60x60		
13050	80x40		
13060	80x60		
13070	100x40		
13080	100x60		



efapel.com



Serpins,
3200-355 Serpins
Portugal

Portugal
efapel@efapel.com
+351 239 970 130

Export
export@efapel.com
+351 239 970 135

SAT Technical Support Service
sat@efapel.com
+351 239 970 132

